

Installation and Maintenance Instruction Manual

Differential pressure gauge, model F5502

for industrial application in the following configuration:

- ###F5502### differential pressure gauge without switching contact
- ###F5502###Q### differential pressure gauge with integrated micro switches



Table of contents:

1	General remarks.....	3
1.1	Purpose of this Manual.....	3
1.2	Symbols.....	3
1.3	Limits of liability.....	3
1.4	Copyright.....	3
1.5	Warranty.....	3
1.6	Manufacturer’s address, customer services.....	3
2	Safety.....	3
2.1	General sources of hazards.....	3
2.2	Use in accordance with intended purpose.....	3
2.3	Operator’s responsibility.....	4
2.4	Staff qualifications (target group assessment).....	4
2.5	Signs/Safety markings.....	4
2.6	Safety equipment.....	4
2.7	Environmental protection.....	4
3	Technical data.....	4
4	Labeling on the device.....	5
5	Construction and function.....	5
5.1	Overview.....	5
5.2	Description of function.....	5
5.1	Description of components.....	5
5.2	Accessories.....	5
6	Transport.....	5
6.1	Safety.....	5
6.2	Transport inspection.....	6
6.3	Storage.....	6
7	Assembly/Installation.....	6
7.1	Safety.....	6
7.2	Preparations (requirements for the installation location).....	6
7.3	Mounting/Installation.....	6
7.4	Starting up.....	7
7.5	Subsequent relocation of the gauge (by the customer).....	8
8	Servicing.....	8
8.1	Safety.....	8
8.2	Check on function, and recalibration.....	8
8.3	Cleaning and maintenance.....	8
9	Faults.....	8
9.1	Safety.....	8
9.2	Conduct in the event of faults.....	8
9.3	Fault table.....	8
9.4	Conduct following fault rectification.....	9
10	Removal, disposal.....	9
10.1	Safety.....	9

10.2	Removal.....	9
10.3	Disposal.....	9
11	Appendix.....	9
11.1	Data sheet for differential pressure gauge F5502.....	9
11.2	CE Declaration of conformity.....	10

1 General remarks

1.1 Purpose of this Manual

This Operating Manual contains fundamental and essential advice to be followed for the installation, operation and servicing of the device. It must be read without fail before assembly and start-up of the device by the fitter, the operator and the specialist personnel responsible for the device. This Operating Manual must be available at the point of use at all times.

The following sections about general safety information (2) and also the following specific advice regarding the intended purposes (2.2) and through to disposal (10.3) contain important safety information which, if not followed, may result in risks for people and animals, or to property and buildings.

1.2 Symbols



Warning!

This indicates a possibly hazardous situation where failing to follow advice may result in risks to people, animals, the environment and buildings.



Information!

This emphasizes key information for efficient, fault-free operation.

1.3 Limits of liability

Failure to respect this safety information, the envisaged uses or the limit values relating to use indicated in the technical data for the device may result in risk or to injury to people, the environment or the plant.

Claims for compensation for damage against the device supplier are excluded in such an eventuality.

1.4 Copyright

This Operating Manual may only be copied and passed on as a complete document without the special permission of the publisher.

1.5 Warranty

For the product described here, we offer a warranty pursuant to Section 6 Guarantee in Respect of Defects in our General Terms and Conditions of Delivery and Payment.

1.6 Manufacturer's address, customer services

Ashcroft Instruments GmbH
Max-Planck-Strasse 1
D-52499 Baesweiler. Germany

Tel.: +49 (0) 2401/808-888
Fax.: +49 (0) 2401/808-999
E-mail: customer.service@ashcroft.com
Web: www.ashcroft.eu

2 Safety

2.1 General sources of hazards

Pressure gauges are pressurized parts where failure can result in hazardous situations. The selection of pressure gauge should be made in accordance with the rules set out in EN 837-2.

2.2 Use in accordance with intended purpose

The devices are only to be used for the intended purpose as described by the manufacturer.

The devices are used for direct display of differential pressure.

The integrated switching elements are SPDT snap action micro switches. If the set limit values are exceeded, the output circuits are opened or closed.

For each use scenario, the corresponding set-up regulations must be respected. The use in explosion risk areas is not permitted.

2.3 Operator's responsibility

Safety instructions for proper operation of the device must be respected. They are to be provided by the operator for use by the respective personnel for installation, servicing, inspection and operation. Risks from electrical energy and from the released energy of the medium, from escaping media and from improper connection of the device must be eliminated. The details for this are to be found in the corresponding applicable set of regulations, such as DIN EN, UVV (accident prevention regulations) and in sector-specific instances of use (DVWG, Ex- GL, etc.) the VDE guidelines and the regulations supplied by local utilities companies.

The device must be taken out of service and secured against inadvertently being restarted, if the presumption is that risk-free operation is no longer possible (see Chapter 10: Faults).

Conversion works or other technical alterations to the device by the customer are not permitted. This also applies to installation of spare parts. Possible conversions or alterations may only be carried out by the manufacturer.

The operational safety of the device is only guaranteed where it is used for its intended purpose. The specification of the device must be adapted to the medium used in the plant. The limit values indicated in the technical data must not be exceeded.

The safety information detailed in this Operating Manual, existing national regulations for accident prevention, and the operator's internal regulations regarding working, operations and safety must be respected.

The operator is responsible for all specified servicing, inspection and installation works being carried out by authorized and qualified specialists.

2.4 Staff qualifications (target group assessment)

The device may only be installed and started up by specialist staff who are familiar with installation, start-up and operation of the product.

Specialist staff are people who are able to assess the work assigned to them on the basis of their specialist training, their knowledge and experience and their knowledge of the relevant standards, and can identify possible risks.

2.5 Signs/Safety markings

The pressure gauge and its surrounding packaging carry markings. These markings show the article number, measurement range and manufacturer. The pressure gauge can be provided with additional signs and safety markings advising on special conditions:

- Advice on the filling liquid
- Advice on calibration
- Oil-can deleted (if oxygen is used)

2.6 Safety equipment

This device is constructed with separate pressure chambers and case for display and can be considered as solid front safety design. For a description, please refer to Chapter 5.2. The window uses multi-layer safety glass.

2.7 Environmental protection

This device may optionally contain a filling liquid (e.g. glycerin or silicone oil). The provisions set out in the REACH regulation on production and use of chemicals are to be respected, and the relevant safety data sheets from the manufacturers of the chemicals are available on our website for download.

Optional this device contains electrical components. The provisions set out in the WEEE regulation EU directive 2002/96/EC on electrical and electronically equipment are to be respected, and the products are registered at the EAR under the number DE 26646349.

3 Technical data

The detailed technical information can be found in the documents in the Appendix, Chapter 11.

4 Labeling on the device

The label with the serial number and type designation is located on the outside of the housing. The materials identifier is encoded in the type designation.

5 Construction and function

5.1 Overview

- | | |
|---------------------|--------------|
| 1. Pressure chamber | 2. Movement |
| 3. Push rod | 4. Diaphragm |

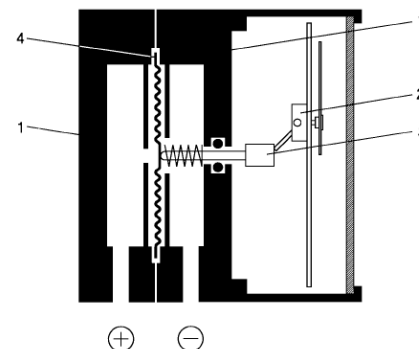

5.2 Description of function

The pressures to be compared act on a flexible stainless steel diaphragm. The diaphragm is mechanically linked by a rigid connecting rod with the movement.

When pressures are equal on both chambers, the diaphragm is at zero position. When there is a difference in pressures acting on the diaphragm, the diaphragm deflects away from the high pressure side, towards the lower pressure side, causing a displacement of the connecting rod.

A precision mechanism translates the linear displacement of the diaphragm connecting rod to angular movement of the gauge's dial pointer. The pointer's displacement range of 270° corresponds to the full scale differential pressure.

5.1 Description of components

5.1.1 Scale with pointer

The differential pressure gauge is equipped with a dial face and pointer pursuant to EN 837-3, nominal size 100 mm or 160 mm.

5.1.2 Instrument connection

The instrument connection is located on the underside of the differential pressure gauge and can be a threaded.

5.2 Accessories

Please contact the manufacturer regarding special tools and accessories.

6 Transport

6.1 Safety

The differential pressure gauge should be protected against the effects of knocks and impacts. The device should only be transported in the packaging provided, to protect against glass breakage. The device should only be transported in a clean condition (free of residues of measuring media).

6.2 Transport inspection

The delivery must be checked for completeness and damage during transport. In the event of damage during transport, the delivery must not be accepted, or only accepted subject to reservation of the scope of the damage being recorded and, if necessary, a complaint initiated.

6.3 Storage

The differential pressure gauge must be stored in dry, clean conditions, within a temperature range of -40 to +60 °C, protected against direct exposure to sunlight and protected against impact damage.

7 Assembly/Installation

7.1 Safety

To ensure safe working during installation and servicing, suitable shut-off valves must be installed in the plant (see 5.2 Accessories), enabling the device:

- To be depressurized or taken out of operation;
- To be disconnected from the mains supply for repair or checks within the relevant plant;
- Or to enable function tests of the device to be performed "on site".

During the works to mount/install the gauge, the plant must be protected against being switched back on.

7.2 Preparations (requirements for the installation location)

- A check on suitability of the device for the medium to be measured, the scope of the measurement range and of the protection against special conditions such as vibrations, pulsations and pressure spikes.
- A bracket must be installed to support the pressure gauge if the metering pipe is not able to provide adequate support.
- The installation location should be chosen such that the work-spaces for operating personnel are not located to the rear of the pressure gauge.

7.3 Mounting/Installation

7.3.1 Process connection

The instrument is intended and factory adjusted for vertical mounting, pressure ports downward. When mounted in other orientation (max. $\pm 10^\circ$) the pointers' zero position needs to be adjusted (see 7.4.1 Zero point adjustment).

- Connection to be undertaken by authorized and qualified specialist staff only.
- Use only with the mechanical process connection provided – regarding the configuration, see order code on the device type label, with a matching threaded seal.
- When connecting the device, the pipes must be depressurized.
- The pressure metering pipe must be laid inclined in such a way that, for example, for measurements of fluids no air pockets can form, and for measurements of gases no water pockets. If the necessary incline is not achieved, then at suitable points water separators or air separators must be installed.
- The pressure metering pipe must be kept as short as possible and laid without sharp bends, to avoid the occurrence of irritating delays.
- The instruments pressure ports are marked by "+" and "-" symbols:
 - "+" port must be connected to the higher pressure
 - "-" port must be connected to the lower pressure.
- With liquid measurement media, the pressurized connection pipe must be degassed, since any gas bubble inclusions result in measurement error.
- If water is used as the measurement medium, the device must be frost-protected.



Safety notice: Only mount using the correct open-jawed wrench, and do not twist the device itself.

7.3.2 Electrical connection



Take note of the electrical data in the EU design type test certification and the locally-applicable regulations and guidelines for installing and operating electrical plant in explosion risk areas (e.g. EN 60079-14, EN 50281-1-2 etc.).

- Connection to be undertaken by authorized and qualified specialist staff only.
- The electrical connection of the device is to be undertaken in accordance with the relevant regulations of the VDE and the regulations supplied by the local utilities company.
- Disconnect the plant from the mains supply before wiring electrical connections.
- Install appropriate fuses upstream.

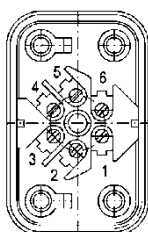

Please refer to type label for configuration of connections.

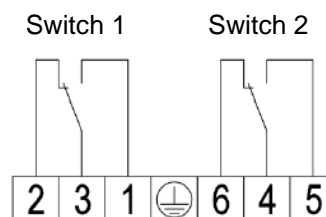

7.4 Starting up

The precondition for start-up is proper installation of all electrical feed lines and metering pipes. All connecting lines must be laid such that no mechanical forces can act on the device.

Before start-up, the seal on the pressurized connection line must be checked.

7.4.1 Zero point adjustment

The differential pressure gauge is factory adjusted therefore in normal case adjustment during installation is not necessary. On this devices zero point adjustment on site is possible. For this, proceed as follows:

- Equalize pressure in both chambers.
- Disassemble screw plug.
- Use zero point adjustment screw to set the pointer to zero.
- Mount screw plug



Filled Models need to be vented before commissioning by opening the air valve on the upper side of instrument!

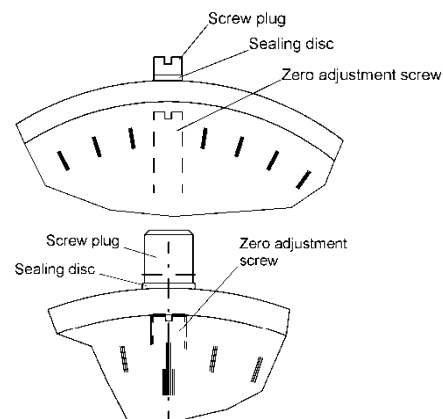

7.4.2 Setting the switch point

- Unscrew plugs from cover.
- Set desired switching points according to marks on reference value by screwdriver. Achievable accuracy: 5% F.S.. More exact settings can be achieved by using accessories like pressure test gauge, ohmmeter on site or ex-factory.
- Screw the plugs in and close the case.



Switching point adjustment

7.4.3 SPDT Micro switch contact function

Function 1: Normally closed (NC)

Function 2: Normally open (NO)

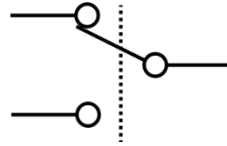

7.5 Subsequent relocation of the gauge (by the customer)



Recommendation: Do not remove the differential pressure gauge from one metering point and fit it in a different place, as there is a risk of the measuring media being mixed, with unforeseeable chemical reactions.

8 Servicing

The device is maintenance-free. However, to ensure reliable operation and a long lifetime for the device, we recommend that it is checked regularly.

8.1 Safety

When undertaking servicing work on the device, the pressure lines must be depressurized, the electrical connections isolated from the mains supply, and the plant secured against being switched on again.

8.2 Check on function, and recalibration

The check on function and recalibration is carried out at regular intervals, depending on the application. The precise testing cycles should be adjusted in line with the operating conditions and ambient conditions. In the event of various device components interacting, the operating instructions for all other devices should also be taken into account.

- Check on display.
- Check on function, in conjunction with downstream components.
- Check of pressurized connection pipes for seal condition.
- Check of electrical connections.

8.3 Cleaning and maintenance

Cleaning is carried out using a non-aggressive cleaning agent, with the ventilation valve closed and respecting the protection category of the device.

9 Faults

9.1 Safety

Defective or faulty pressure gauges put the operational safety and process safety of the plant at risk, and can lead to a risk or injury to persons, the environment or the plant.

9.2 Conduct in the event of faults

All defective or faulty devices must be taken out of service. If a repair is required, the device must be sent directly to our Repairs Department. We request that all returns of devices are agreed with our Service Department.

9.3 Fault table

Possible situations indicating a fault:

- Jerky or random movement of the pointer
- Pointer does not set to zero for pressure less display
- Bent or loose pointer
- Cracked window
- Leaks when the device is filled
- Damage to housing
- Indications that the measurement system seal is imperfect (discoloration to dial display or of filling liquid)

In these instances, replacement of the pressure gauge is always required.

9.4 Conduct following fault rectification

See Chapter 7.3 Mounting/Installation

10 Removal, disposal

10.1 Safety



Residues of measuring media in and on removed gauges can constitute a risk to people, the environment and equipment. Adequate precautionary measures must be adopted. If necessary, the devices must be cleaned thoroughly (see advice in safety data sheets).

10.2 Removal

- When undertaking servicing work on the device, the pressure lines must be depressurized, the electrical connections isolated from the mains supply, and the plant secured against being switched on again.
- Demount the gauge using a suitable tool

10.3 Disposal



Please help to protect the environment and dispose of or recycle the devices and components used in accordance with the applicable regulations.

11 Appendix

11.1 Data sheet for differential pressure gauge F5502

Detailed data sheet is available from supplier's website (see 1.6 Manufacturer's address, customer services)

This Table refers to specific documents:

Model	Description	Document
F5502	Stainless steel differential pressure gauge model F5502	G1.F5502

11.2 CE Declaration of conformity

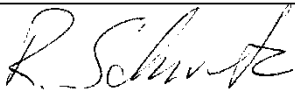
	
<p>Konformitätserklärung EG - Richtlinien</p> <p>Ashcroft Instruments GmbH Max-Planck-Straße 1 D-52499 Baesweiler</p>	<p>Declaration of Conformity EC - direction</p>
<p>Wir erklären hiermit in alleiniger Verantwortung, daß die folgenden Produkte in Übereinstimmung mit den Bestimmungen der benannten EG-Richtlinien sind und die aufgeführten Normen und technischen Spezifikationen zur Anwendung gelangt sind</p>	<p>We hereby declare under sole responsibility that following products are in conformity with the provisions of the following EC-directives and the listed standards and technical specifications have been applied</p>
<p style="text-align: right;">Bezeichnung : Specification :</p> <p style="text-align: right;">Typ / Artikel-Nr. / Baureihe :</p> <p style="text-align: right;">Serien-Nr. : Serial No. :</p> <p style="text-align: right;">Spezifikation : Specification :</p> <p style="text-align: right;">EG-Richtlinie : EC-directive :</p>	<p>Manometer Pressure Gauges</p> <p>T5500, T6500, 1008, 1009, 1320, 1279, 1377, 1379, 2462, 1187, 1188, 1189, 1005, 1082, 1220, N5500, P5500, P6500, 1389, 1320, 1032, 1130, 1131, 1132, 1133, 1134, 1288, 1010, 1017, 3003, 3005, 1084, 1088, F5502, F5503, F5509, F5510, F5512, F6509, 50-1037, 75-1037, 10-1037, 1036, Weksler Type UA 15-1037 (Group 2 Product of PS * DN ≤ 1000 bar) 20-1037 (Group 2 Product of PS * DN ≤ 1000 bar)</p> <p>Ab Lieferdatum 29.05.2002 Supplied from 29.05.2002</p> <p>P≤200 bar und V<0,1 l P≤200 bar and V<0,1 l</p> <p>DGRL 97/23/EG PED 97/23/EC</p>
<p>Hersteller-Unterschrift : Signature of manufacturer :</p> <p>Funktion des Unterzeichners : Function of signer :</p> <p style="text-align: right;">Datum : Date :</p> <p style="text-align: right;">Stempel Stamp</p>	<div style="text-align: center;">  </div> <p style="text-align: center;">Operation Manager</p> <div style="text-align: center;"> <p>ASHCROFT Instruments GmbH Max-Planck-Str. 1 D-52499 Baesweiler Postfach/P.O. Box 1120 D-52490 Baesweiler Tel. 02401/8080 · Fax 02401/7627</p> </div>